

# Canopy | CLED Surface Mount Canopy

CAT#:	Job:	Type:
-------	------	-------

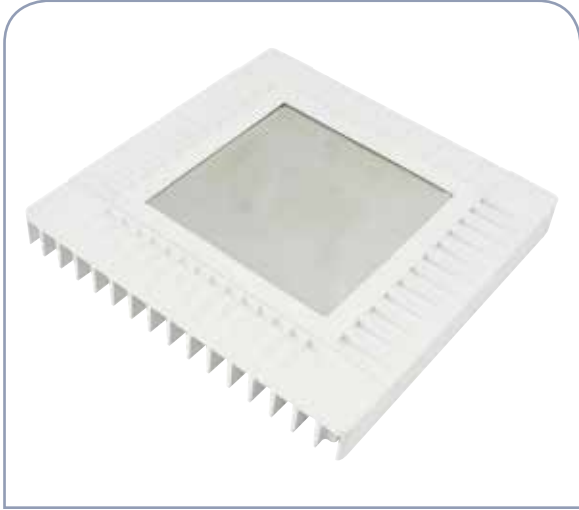

## Features

Built for superior LED performance packed with features

- Stylish vertically finned die-cast heat sink
- Designed for optimal thermal transfer and easy installation
- Made from low-copper marine-grade cast aluminum
- Optical assembly designed to exceed IP66 design standards allowing for light hose-down cleaning
- Thermal frame technology provides state-of-the-art passive cooling in the most demanding environments
- 73 CRI standard
- Listed to UL1598 for use in wet locations
- Operating Temp: -40°C to 40°C
- 0-10v standard dimming
- IP66

## Certifications/Listings



## Ordering Information

CLED		7	UNV	S			MP	
SERIES	OUTPUT	DRIVE CURRENT	MOUNTING	CCT	COLOR	OPTIONS		
CLED LED surface mount fixture	LW 33 Watts LL 66 Watts HL 120 Watts XL 150 Watts	7 700 mA	S Surface Mount <sup>1</sup>	5 5100K 4 4000K 3 3500K	WH White DB Dark Bronze CC Custom <sup>4</sup>	DL Drop Lens OCC <sup>5</sup> Programmable motion control, factory default is 10% light output	MOUNTING PLATE MP Mounting Plate	
			UNV 120-277 HV 347-480					

### ACCESSORIES - Order Separately

Catalog Number	Description
93072702	CLED decorative beauty plate
CLRT1	Surface mounted retrofit for Whiteway Vision, Riviera II, Thunderbird, 21" housing <sup>3</sup>
CLRT2	Surface mounted retrofit for LSI Masters/Dakota, 23" housing <sup>3</sup>
CLRT3	Surface mounted retrofit for Jet Philips Houstonian SHO/RHO, 22" housing <sup>3</sup>
CLEDSJK	Stem and Junction Box
CLED18CP	Retrofit kit for Whiteway Civic, LSI Richmond
CLEDENCP	Cover plate for LSI Encore <sup>2</sup>
SCP-REMOTE	Remote control for OCC option; order at least one per project to program and control
CLED5MK	Surface Mount Kit for surface conduit

### Notes:

- <sup>1</sup> 3/4" Conduit hub for pendant mount
- <sup>2</sup> 13" x 13"
- <sup>3</sup> Measure outside dimension of existing housing
- <sup>4</sup> Contact factory for lead time
- <sup>5</sup> Requires Hubbell SCP-Remote to program sensor

## Ordering Example

Recessed Single Skin/Open Top Canopy  
1. CLED-HL-7-UNV-S-5-WH

Surface Mount Retrofit  
1. CLED-HL-7-UNV-S-5-WH  
2. CLRT1

Recessed Double Skin/Enclosed Soffit  
1. CLED-HL-7-UNV-S-5-WH  
2. CLEDMP



WHITEWAY LIGHTING, A Division of Hubbell Lighting Inc  
1085 Johnson Drive, Buffalo Grove, IL 60089  
800-544-4848 | www.whiteway-ltg.com



# Canopy | CLED Surface Mount Canopy

## Specifications

### Construction:

- Die cast aluminum heat sink
- Shipping weight - 19lbs

### Electrical:

- Universal input voltage 120-277 VAC, 50/60 Hz
- Automatic thermal self-protection
- LED drivers have output power over-voltage, over-current protection and short circuit protection with auto recovery
- LED electrical assembly, including PR devices, consumes no power in the 'off' state
- Surge protection standard
- Expected life: 65,000 hours

### Warranty:

- 5 year

### Listings:

- UL
- DesignLights Consortium qualified
- cUL

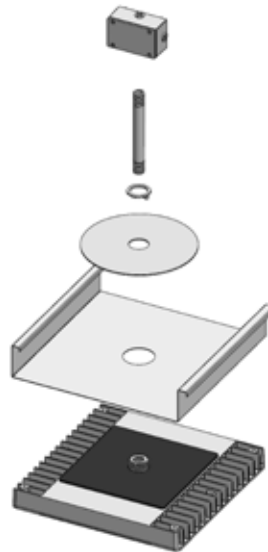
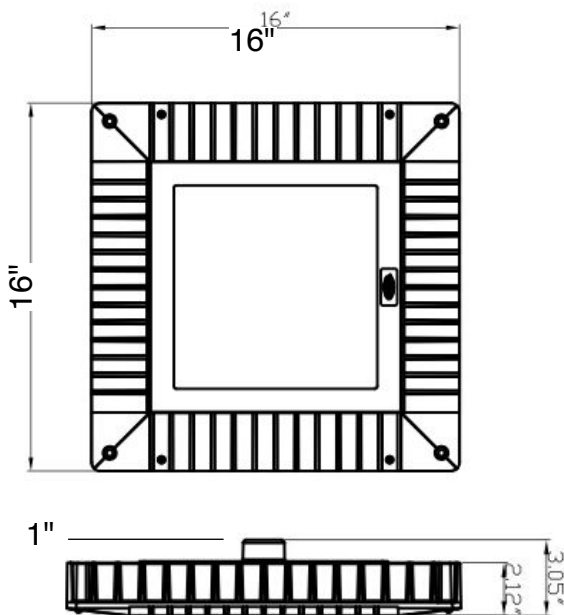

## Performance Summary

Distribution	Engine	Delivered Lumens	No. of LEDs	CCT	Wattage	Lumens per watt	Replaces
Type V	LW-700	4,397	120	5100K	32	136	100-175W
	LL-700	9,938	312	5100K	66	150	175-250W
	HL-700	16,233	312	5100K	120	123	320-400W
	XL-700	19,596	336	5100K	150	130	750-1000W

All performance data has been acquired by physical test reports conducted to LM-79-08 standards in a controlled testing laboratory.

## Accessories

**CLEDSMK** used for surface mounting and wired with surface mounted conduit and/or in series wiring.

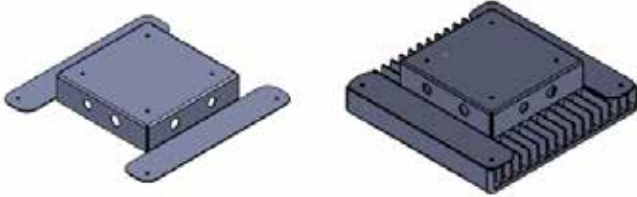

## CLRT KITS



CLRT1



CLRT2



CLRT3

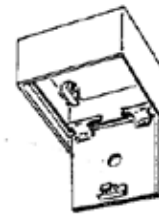

\*CLRT Kits designed to retrofit 21"-23" surface mount boxes. Consult CLRT spec sheet for full information.

## CLEDSJK

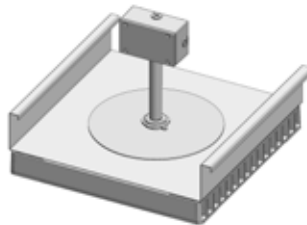

\*CLEDSJK consists of Hubbell Raco 5330-0 Bell Box and 6" conduit stem.

## CLED18CP



\*13" X 23"

## CLEDENC



\*13" X 13"

## 93072702

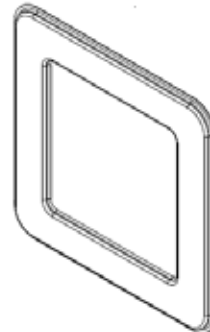

\*26" X 26"